

VERMEIREN

Sigma Sigma 230

INSTRUCTION MANUAL





Content

Preface	2
1 Your product	3
1.1 Description	3
1.2 Options	5
2 Before use	6
2.1 Intended use	6
2.2 General safety instructions	6
2.3 Symbols on the wheelchair	7
2.4 Transport.....	7
2.5 First use and storage	10
3 Using your wheelchair	11
3.1 First ride.....	11
3.2 Driving outdoors.....	11
3.3 Operating console.....	13
3.4 Brake and free-wheel lever	13
3.5 Battery switch.....	14
3.6 Moving to/from wheelchair	14
3.7 Comfort adjustments.....	15
3.8 Battery status and charging	18
4 Maintenance	19
4.1 Time of maintenance.....	19
4.2 Instructions for maintenance	20
4.3 Troubleshooting	20
4.4 Reuse	21
4.5 End of use.....	21
5 Technical specifications	22



Preface

Congratulations! You are now owner of a Vermeiren wheelchair!

This wheelchair is made by qualified and committed personnel. It is designed and produced according to high quality standards, guarded by Vermeiren.

Thank you for your trust in the products of Vermeiren. To support you on the use of this wheelchair and its operating options, this manual is offered. Please read it carefully; it will help you to get familiar with the operation, capabilities and limitations of your wheelchair.

If you still have questions after reading this manual, do not hesitate to contact your specialist dealer. He/she will be glad to help you.

Important note

To ensure your safety and to prolong the lifetime of your product, please take good care of it and have it checked and serviced on a regular basis.

This manual reflects the latest product developments. Vermeiren has the right to implement changes to this type of product without any obligation to adapt or replace similar products previously delivered.

Pictures of the product are used to clarify the instructions in this manual. Details of the depicted product may deviate from your product.

Information available

On our website <http://www.vermeiren.com/> you will always find the most recent version of the information in this manual. Please consult this website regularly for possible updates.

Visually impaired people can download the electronic version of this manual and have it read out by means of a text-to-speech software application.



This user manual
For user and specialist dealer



User manual of applied operating console and battery charger.
For user and specialist dealer



Installation instructions (Instructions for detail adjustments and (dis)assembly)
For specialist dealer



Service manual for wheelchairs
For specialist dealer



EC declaration of conformity

1 Your product

1.1 Description

This Sigma, Sigma 230 wheelchair is easy to operate and can be used indoors as well as outdoors. The wheelchair has a mid-wheel drive which makes stable driving possible. Depending on the type of wheelchair and installed options, electrical adjustment of backrest, seat and leg rest is possible.

The following pictures shows all parts that are relevant to the user. In the operation and maintenance section, these parts are described if applicable.

i Before using your wheelchair, check the technical details and limits of intended use. See chapter 5.

To adjust your wheelchair, see the comfort adjustments in § 3.7 and/or the adjustments in the installation manual. Also consult our website <http://www.vermeiren.com/>



1. Backrest
2. Arm pad (2x)
3. Seat
4. Footrest B06 (2x)
5. Footplate B06 (2x)
6. Battery housing
7. Front wheel (2x)
8. Mid wheel/drive wheel (2x)
9. Rear wheel (2x)
10. Armrest (2x)

Figure 1 **Important parts**



Figure 2 *Important parts, continued*

- 23. Calf rest BZ10E (2x)
- 24. Footplate BZ10E (1x)
- 25. Footrest BZ10E (1x)



Figure 3 *Important parts, continued*



1.2 Options

Type	Description
SE30	Manual seat adjustment
SE34	Manual backrest adjustment
SE36	Manual backrest adjustment; max. inclination angle 30° with gas springs
SE39	Electrical seat; max. inclination angle 20° Electrical backrest; max. inclination angle 30° (2 actuators)
SE40	Electrical seat; max. inclination angle 20°; one actuator
SE41	Electrical backrest; max. inclination angle 30°; one actuator
SE42+SE40	Vertical lift, max.300 mm Electrical seat; max. inclination angle 45° (2 actuators)
SE42+SE39	Vertical lift, max.300 mm Electrical seat; max. inclination angle 50° Electrical backrest; max. inclination angle 30° (3 actuators)
SE43	Electrical seat; max. inclination angle 50° Electrical backrest; max. inclination angle 30° (2 actuators)



2 Before use

2.1 Intended use

In this paragraph a brief description of the intended use of your wheelchair is given. Additionally, relevant warnings are added to the instructions in the other paragraphs. In this way we would like to make you aware of the possible misuse that may appear.

- Indications and contraindications: This wheelchair is meant to be operated by the user sitting in the wheelchair. The wheelchair is designed and produced to be a transport aid for users who suffer from paralysis, loss of limbs or limb deformations/defects, heart insufficiencies, ... You should NOT use this wheelchair if you suffer from physical or mental impairments that may put you, or other people, in danger when driving the wheelchair. For this reason, consult your doctor first and make sure that your specialist dealer is informed about his advice.
- This wheelchair is suitable for indoor and outdoor use.
- This wheelchair is designed and produced solely to transport/transfer one (1) person with a maximum weight of 140kg. It is not designed for transportation of goods or objects, nor for any use other than previously described.
- Only use accessories and spare parts approved by Vermeiren.
- Please read all technical details and limits of your wheelchair in chapter 5.
- The warranty on this product is based on normal use and maintenance as described in this manual. Damage to your product caused by improper use or lack of maintenance will cause the warranty to lapse.

2.2 General safety instructions

 CAUTION Risk of injuries and/or damage

Please read and follow the instructions in this manual. Otherwise you may get injured or your wheelchair may get damaged.







Keep the following general warnings in mind during use:

- Do not use your wheelchair if you are under influence of alcohol, medicines or other substances that may influence your driving abilities.
- Be aware that some parts of your wheelchair may get very hot or cold due to ambient temperature, solar radiation, heating devices or due to the motor drive during the ride. Be careful when touching. Wear protective clothing if the weather is cold. After a ride, wait until the wheelchair/motor has cooled down.
- Before switching the wheelchair on, be aware of the environment/situation in which you are located. Adjust your speed to this before driving off. We advise you to use the slowest speed setting to drive indoors. For outdoor driving you can adjust the speed to a suitable speed at which you feel comfortable and safe.
- ALWAYS keep in mind that your wheelchair may stop suddenly due to a discharged battery or a protection that prevents your wheelchair from further damage. Also check the possible causes mentioned in § 4.3. Use your safety belt to prevent injuries.
- Your wheelchair has been tested for electromagnetic compatibility and complies with the standard, see chapter 6. Nevertheless, sources of electromagnetic fields may influence the driving performance of your wheelchair, such as the fields of mobile phones, power generators or high-power energy sources. On the other hand, the electronics of your wheelchair can affect other electronic appliances too, such as alarm systems of shops and automatic doors. We therefore advise you to check your wheelchair regularly for damage and wear, since these may enlarge the interference (see also chapter 4).

- Only drive on flat surfaces where both driving wheels touch the ground and where there is sufficient contact to operate the wheelchair safely.
- Alterations or substitutions should not be made to the wheelchair securement points or to structural and frame parts or components without consulting the wheelchair manufacturer.
- Make sure that your hands, clothes, belts, buckles or jewellery don't get caught by wheels or other moving parts during use.

2.3 Symbols on the wheelchair

The symbols in following list are applicable to your wheelchair. Symbols can be found in the relevant ISO standard (ISO 7000, ISO 7001 and IEC 417).

	Maximum weight of the user in kg
	Indoor/outdoor use (battery charger excluded)
	Indoor use only (battery charger)
	Maximum safe slope in ° (degrees).
	Maximum speed
	Type designation
	Risk of entrapment

2.4 Transport

 Risk of damage

Take action to protect the wheelchair from being damaged during transport.

i The wheelchair cannot be disassembled without tools and is relatively heavy to carry.

2.4.1 Moving out of the way

Use the operating console to drive the wheelchair to its destination.

Otherwise, put the wheelchair in free-wheel mode (see §3.4) and use the push bar to move it.

2.4.2 Transport by aircraft

Since the wheelchair is equipped with non-spillable AGM batteries, it is possible to transport the wheelchair (as a whole) by aircraft. Consult your airline for the correct handling procedures before booking your flight. Before handing your wheelchair over to the airport personnel, disconnect the battery from the wheelchair, see § 3.5.



2.4.3 Transport by vehicle, as luggage

 **WARNING** Risk of injuries and damage

- Make sure that the free-wheel lever is in braking position during transport, see § 3.4.
- Do not drive the wheelchair into the vehicle while the user is still seated in it.

To drive the wheelchair into the vehicle:

1. Use the operating console to return your wheelchair to stable position, see § 3.3.
2. Remove all mounted accessories such as trays and respiratory equipment and secure them in a safe place.
3. Use a ramp to drive the wheelchair in the luggage compartment of the vehicle:
 - Set the wheelchair to the lowest speed setting.
 - Operate the joystick to drive the wheelchair forwards up the ramps and into the vehicle. Walk next to the wheelchair and follow it as it drives, but do NOT walk with it on the ramps.
 - Turn OFF the operating console.
4. If luggage and passenger compartments are NOT separated or enclosed, fasten the wheelchair frame securely to the vehicle using the six-points strap-tie-down system (see Figure 4).

To drive the wheelchair out of the vehicle:

1. FIRST, switch ON the operating console.
2. Put the wheelchair in free-wheel mode.
3. Stand on the ramps and pull the wheelchair towards you. Walking backwards, the wheelchair will gently drive off the ramps.

2.4.4 Transport by vehicle, as seat for user

i **The wheelchair has passed the crash test of ISO 7176-19: 2008 and, as such, has been designed and tested for use only as forward-facing seat in a motor vehicle.**

The wheelchair is tested dynamically with the ATD (anthropomorphic test device) using a six-points strap-tie system and a 3-point occupant-restraint system. Nevertheless, the user should preferably be transferred to one of the seats inside the vehicle and use vehicle's restrain system. The wheelchair should be stored as luggage in a separate (cargo) compartment, see §2.4.3

 **WARNING** Risk of injuries and damage

Use wheelchair's pelvic belt and the applicable three-points belt in the vehicle to prevent head and chest impacts with the vehicle.

Do not use postural supports to restrain the user in the vehicle unless they are labelled as being in accordance with the requirements specified in ISO 7176-19:2008.

Following involvement in any type of vehicle collision, have your wheelchair inspected by the specialist dealer or manufacturer's representative before reuse.

Securing the wheelchair

1. Make sure that the vehicle has a suitable wheelchair six-points strap-tie-down and occupant-restraint system conform ISO 10542, and that both systems are not frayed, contaminated, damaged or broken.
2. Use the operating console to return your wheelchair to stable position, see §3.6.
3. Remove all mounted accessories such as trays and respiratory equipment and secure them in a safe place. If not possible, secure them to the wheelchair but positioned away from the occupant with energy-absorbing padding placed between tray and user.
4. Use a ramp to drive the wheelchair (with user) in the vehicle according to the instructions in §3.2.1.

5. Position the user facing forward in the travelling direction, centrally between the tie-down rails mounted in the floor of the vehicle.
6. Make sure that the user is sitting as upright as possible. If the user's condition prevents this, carry out a risk assessment to evaluate the user's safety during transit.
7. Turn the operating console OFF and make sure that the free-wheel lever is in braking mode, see §3.4.

i 8. The location of each securement point on the wheelchair is marked with the following symbol:

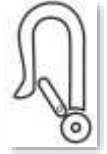

9. Verify that the tiedown end-fitting is compatible with the wheelchair securement points.
10. Attach the front securement-strap hooks to the securement points (A+B) on the wheelchair following the supplier instructions of the strap-system, see Figure 4.
11. Turn free-wheel lever in free-wheel position and roll the wheelchair backwards to pull the front straps tight, see §3.4.
12. Attach the rear securement-strap hooks to the securement points (C+D+E+F) on the rear in the same way.
13. Turn free-wheel lever back in braking position, see §3.4.

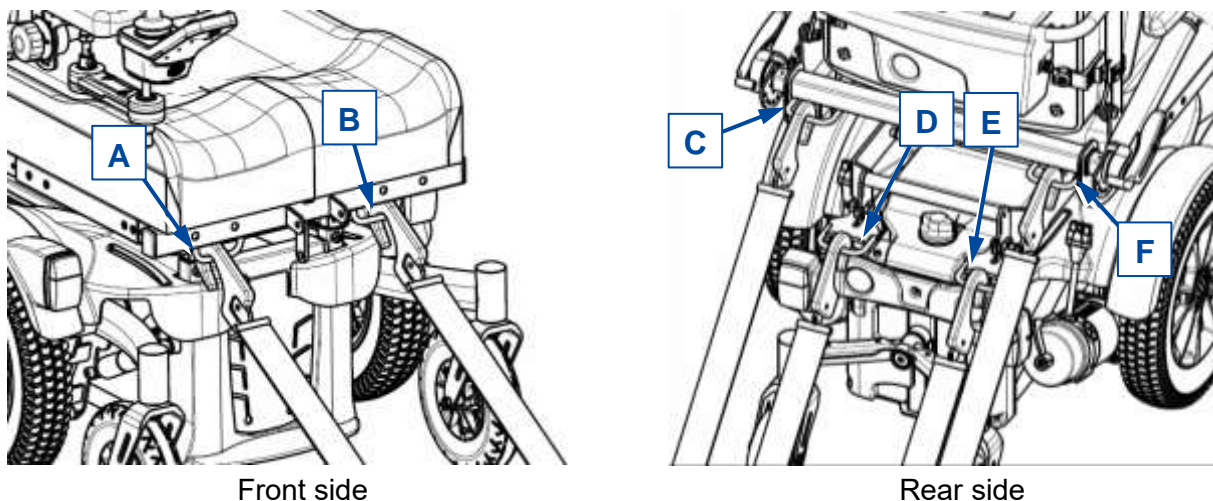

Figure 4 **Securement points**

Securing the user

1. Attach the wheelchair's pelvic belt.
2. Attach the user-restraint belts of the vehicle according to the instructions of the strap-system manufacturer.

i Wear the pelvic belt low across the front of the pelvis, so that the angle of the pelvic belt is within the preferred zone of 30° to 75° to the horizontal, similar to that shown in the figure.
A steeper (greater) angle within the preferred zone is desirable.

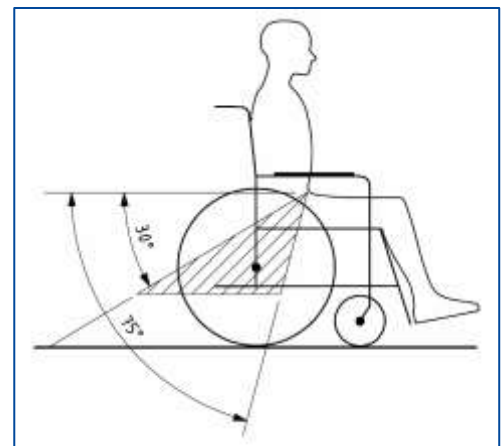

Figure 5 **Angle of pelvic belt**

3. Adjust the belt tightly according to the instructions of the strap-system manufacturer, consistent with the user's comfort.
4. Ensure that the restraint belt connects in a straight line to the anchor point in the vehicle and that no bends in the belt are visible, for instance at the axle of the rear wheel.

5. Position the seatbelt buckle so that the release button will not be contacted by wheelchair components during a crash.
6. Make sure that belts are not twisted or held away from the body as shown in figure 6.
7. Make sure that the shoulder-belt restraints fit over the shoulders, see figure 7.

Belt restraints must not be held away from the body by wheelchair components such as armrests or wheels.

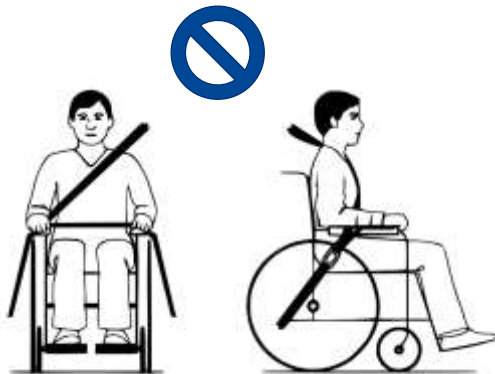

Figure 6 *Improper belt-restraint fit*

Belt restraints make full contact with shoulder, chest and pelvis.

Pelvic belt low on the pelvis near the thigh-abdominal junction

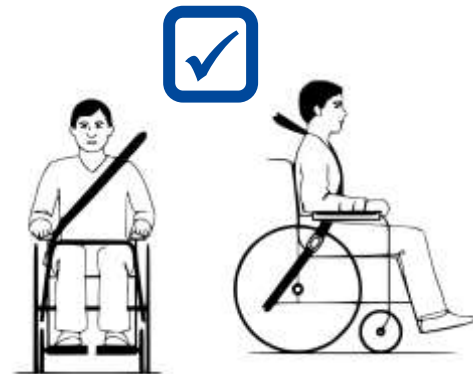

Figure 7 *Proper belt-restraint fit*

2.5 First use and storage

CAUTION

Risk of battery damage

- Never completely discharge the battery.
- Do not interrupt the charging cycle; only disconnect the battery charger when the battery is fully charged.
- Make sure that your wheelchair is stored dry to prevent mould to grow and damage the upholstery. If necessary, use a protective cover.
- Check the technical details for storage, see chapter 5.

Ensure that the battery has been fully charged before using your wheelchair, ask your dealer if this has already been done or not. To charge, follow the charging instructions in §3.8.

3 Using your wheelchair

**WARNING**

Risk of injuries

- First read previous chapters and inform yourself about the intended use. Do NOT use your wheelchair unless you have read and fully understood all instructions.
- Also read the instructions in the operator console manual and battery charger!
- In case of doubts or questions, do not hesitate to contact your local specialist dealer, your care provider or technical adviser to help you with this.

3.1 First ride

**CAUTION**

Risk of injuries and damage

- Always keep the swing range of footrest and operating console in mind to prevent bystanders from being injured or objects from being damaged.
- Always unplug the battery charger from the wheelchair before starting to drive.



- Make sure that you are familiar with the operation of your wheelchair before using it in crowded and possibly dangerous places. First exercise at a spacious, open area with little bystanders.
- Investigate the effects of shifting the centre of gravity on the behaviour of the wheelchair, for example on up or down gradients, on laterally sloping ground, or when overcoming obstacles. Obtain support from an attendant.
- The surface of the controller gets slightly warm during use.
- While driving backwards, the speed is reduced.

1. Make sure that:
 - the wheelchair is on a flat surface;
 - the battery is fully loaded, see § 3.8;
 - The motor is coupled, see § 3.4;
 - the tyres have the correct tyre pressure, see § 0;
 - the wheelchair is adapted to your needs and comfort, see §3.7;
 - you have the proper sitting position, see § 3.6.
2. Follow the instructions in the operating console manual.
3. Switch on your wheelchair.
4. Turn the speed control to the lowest speed setting.
5. Exercise how to drive and make adjustments to the wheelchair.
6. If you feel confident enough, you can try to drive at higher speed.
7. Now try to turn, in forward and backward direction. Repeat this a few times.
8. Make sure that your wheelchair stands stable, when ending the ride.
9. Switch off your wheelchair.

3.2 Driving outdoors

**WARNING**

Risk of accident - Adjust your driving behaviour and speed.

- Take the local road traffic law into consideration; it may differ per country. This counts for driving on pavements, unpaved roads or paved roadways.
- Do not drive on roads with heavy traffic.
- Take the weather conditions into consideration. Avoid driving by moist weather, extreme heat, snow, black ice, freezing temperatures; see technical specifications in chapter 5.



- Even with your wheelchair lights on, it is not suitable to drive on public roads at poor visibility (darkness, mist, twilight). Make sure that you are well visible, also during daylight hours, by using fluorescent clothing and/or by using own lighting at the front and rear side of the wheelchair.
- Be aware of other road users to whom your wheelchair may be an obstacle. Pay special attention during turning and reversing. If you are not acquainted with how to drive backwards, first practice in an open area. Indicate the direction you are intending to go before turning.
- Try to drive straight in small passages to prevent getting trapped.
- Keep the braking distance in mind. Be aware that the braking distance depends on speed, surface, weather conditions, slope and weight of the user.

3.2.1 Cope with slopes, kerbs, obstacles or ramps



CAUTION

Risk of injuries by unexpected movement

- Use a restraining safety belt to secure yourself sitting in the wheelchair.
- Pay attention if the road is sandy, has soft ground, holes or gaps that may cause entrapment of the wheels and/or decreasing of the traction of the mid wheel.
- Do NOT drive on slopes, obstacles, steps or kerbs larger than the size described in the technical specifications in chapter 5. If steeper ramps can not be avoided, see the instructions in §2.4.3.
- Always approach a kerb from the front.
- Do not put your wheelchair in free-wheel mode on a slope. The wheelchair may start moving, causing injuries to you or bystanders.
- Do not use your wheelchair on an escalator or stairs.
- Only use ramps approved by Vermeiren and do not exceed their maximum load.



When you stop on a slope, the brake will work automatically to prevent the wheelchair from running forward or backward.

CAUTION

Risk of damage

- Always park your electric wheelchair on horizontal flat surfaces and on sites that are easily accessible.
- If necessary, take a short run-up to speed up the wheelchair to mount a slope, obstacle, kerb or ramp. Prevent that you or your wheelchair has to cope with a large recoil.
- Make sure that the wheelchair does not touch the ground or ramp due to the inclination of the wheelchair.
- Be aware that the braking distance on downhill slopes can be significantly larger than on level ground.

Procedure

- Start your drive according to the instructions in § 3.1, step 1.
- To move the wheelchair up or down stairs/steps, use lifting equipment or a ramp. If these are not available, it can be lifted manually by at least three persons, grasping the frame firmly with both hands. Do not use the backrest, footplate(s), armrests, or wheels to grasp the wheelchair.
- To cope with obstacles or inclinations:
 1. Adjust the wheelchair to its most stable position, see § 3.6.
 2. Drive as slow as possible to cope with the obstacle or inclination.

3.3 Operating console

 CAUTION Risk of injuries or damage

- Be aware that the stability decreases when the wheelchair is adjusted from sitting-strait to inclined position.
- Make sure there is enough space around the wheelchair to operate backrest and seat.

i How to use the operating console is described in a specific user manual, enclosed with the delivery of your wheelchair. If this manual is missing, contact your specialist dealer immediately.

Put the joystick in the neutral (central) position before pressing the on/off button, otherwise the electronics will be blocked. To release this block, switch the operating console off and on again.

Technical protections

The operating console enables you to control all driving components and motors to adjust your body position. For your own safety, and to prevent that the wheelchair gets damaged, movements are monitored by the electronics. This may result in block of movement, speed decrease or complete stop. Consult the user manual of the operating console for more information.

To avoid accidental battery run down, your wheelchair is equipped with an automatic power shutdown system. This system switches off the operating console automatically when it is not operated for a while. If this occurs, simply switch your console back on.

3.4 Brake and free-wheel lever

 CAUTION Risk of injuries or damage

- Only operate the free-wheel lever when your wheelchair is turned OFF. An attendant should operate the free-wheel lever. NEVER operate it from sitting position.
- Do not use the free-wheel mode on slopes and inclinations, see symbol on motor: 

i Make sure that the free-wheel lever is in its braking position BEFORE switching the wheelchair ON. Electromagnetic brakes do NOT function if the wheelchair is in free-wheel mode. This is indicated on the operating console. Driving is not possible.

Your wheelchair is equipped with electromagnetic brakes. The working of the brakes depends on the position of free-wheel lever (13).

The EM brakes function automatically, **only if** free-wheel lever (13) is in braking position (A), see Figure 5. In this situation, the brakes start braking if:

- the wheelchair is OFF;
- the wheelchair is ON and the joystick is released.

Releasing the joystick makes the wheelchair stop gently and activates the brakes.

Operation of free-wheel lever:

- Turn lever clockwise (position B) to put the wheelchair in free-wheel mode. Now, the motor is disconnected. The wheelchair can be moved manually.
- Turn lever anticlockwise (position A) to connect the motor to the drive. This should be done before starting the wheelchair.





Figure 8 *Operating free-wheel lever*

3.5 Battery switch

Your wheelchair is equipped with a battery switch (16) to interrupt the circuit between the power module and batteries. The disconnection is used for safety during transport, maintenance and repairs. It is also possible to remove the battery switch knob to prevent that the wheelchair is moved during your absence.

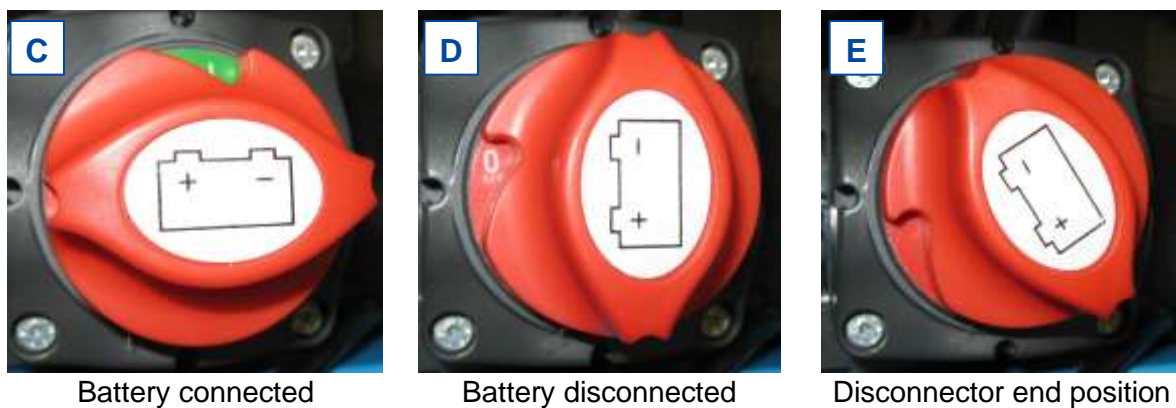

Figure 9 *Battery switch positions*

Operation:

Turn the red battery switch (16)

- clockwise to "I" to connect the battery to the power module [C].
- anticlockwise to "0" to disconnect the battery [D].
- anticlockwise, passing "0" to its end position [E] and remove the knob from the switch.

3.6 Moving to/from wheelchair



CAUTION

Risk of injuries or damage

- In case you cannot perform the transfer in a safe manner, ask someone to assist you.
- Do not stand on the footplate(s) during transfer into or out of the wheelchair.

Transfer

1. Position the wheelchair as close as possible to you when sitting in your chair, couch, seat or bed.
2. Apply the brakes by turning the free-wheel lever to braking position, see § 3.4.
3. Use the operating console to move the backrest and seat to sitting position, see user manual of the console.
4. Fold the footplate(s) upwards to prevent standing on them.
5. If necessary, turn one armrest back/up to make room, see § 3.7.1.
6. Transfer to/from the wheelchair using the strength of your arms or with the help of attendant(s) or lifting equipment.



Sitting in the wheelchair

1. Sit down on the seat with your lower back against the backrest.
2. Turn the footplate(s) down and put your feet on the footplates.
3. Turn armrests down, if applicable.
4. Make sure that your upper legs are horizontal and that your feet are in a comfortable position. Adjust if necessary, see § 3.7.4 and § 3.7.5.
5. Make sure that your arms are bent and are resting comfortably on the arm pads. Adjust if necessary, see § 3.7.1 and § 3.7.2.

Adjusting to stable position

For transport purposes and when you need to negotiate obstacles, the wheelchair must be adjusted to maximise its stability:

- Seat in horizontal position
- Backrest upright
- Armrests in bottom position
- Footplate folded up or adjusted to a higher position to prevent touching the obstacle.
- Operating console turned inwards.

3.7 Comfort adjustments

 CAUTION Risk of injuries or damage

- The following comfort adjustments can be done by the attendant or caretaker. All other adjustments are done by your specialist dealer according to the installation instructions, see preface.
- Always keep the swing range of footrest and operating console in mind to prevent bystanders from getting injured or objects from being damaged.
- Make sure that your fingers, clothes, buckles don't get trapped during adjustment.

3.7.1 Operator console

The operator console has a swivel system and can be turned horizontally to the left/right.

Grab the control support (26) below the operator console and move it left/right to the desired position.



3.7.2 Armrests

Position

The armrests can be turned backwards (up) to make it easier to transfer to/from the seat.

1. Push lever (31) of the toothed clamp (30) slowly down. The arm rest is unlocked (in bottom position).
2. Turn the armrest up/backwards to its end position.
3. Pull lever (31) up to close the toothed clamp. The armrest is locked in end position.

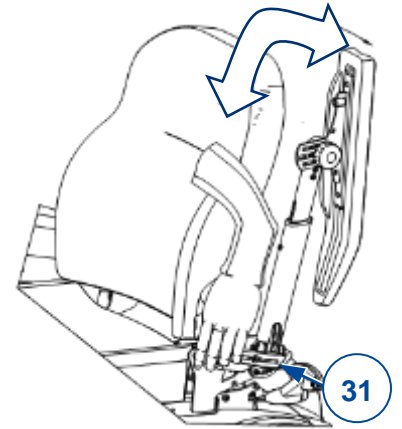

Angle

The same procedure is used to change the angle of the armrest:

1. Repeat previous step 1.
2. Next, hold the armrest in the desired position, while locking it with the lever (31).
3. Repeat this for the second armrest.
4. Make sure that both armrests have the same angle.
5. Make sure that both armrests are firmly secured.



3.7.3 Arm pads

The arm pads (3) can be adjusted in height (stepless) and angle (7,5° step):

1. Turn the star knob (32) a few turns anticlockwise. To adjust the angle, turn it four turns minimally.
2. Pull/push the arm pad lightly to adjust the height.
3. Hold the arm pad at the desired angle.
4. Turn the star knob clockwise until it is finger-tight.
5. Repeat this for the second arm pad.
6. Make sure that both arm pads are firmly secured.



3.7.4 Footrest B06

To remove

1. Pull footrest lever (27) and swing footrest (4) outwards.
2. Lift the footrest to remove it.

To install

1. Hold footrest (4) sideways and hang it in footrest support (28).
2. Swing the footrest inwards until it clicks in position.



3.7.5 Footplate of B06

Angle

To change the angle of the footplate (5):

1. Loosen star knob (34) of toothed clamp (33) a few turns.
2. Turn the footplate up/down and hold it in desired position.
3. Tighten star knob (34).
4. Repeat this for the second footplate.
5. Make sure that both footplates are firmly secured.

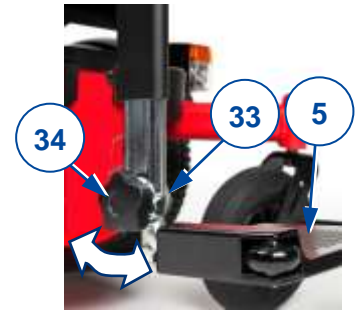

3.7.6 Footplate of BZ10E

Fold the footplate (5) up to make room for passage.

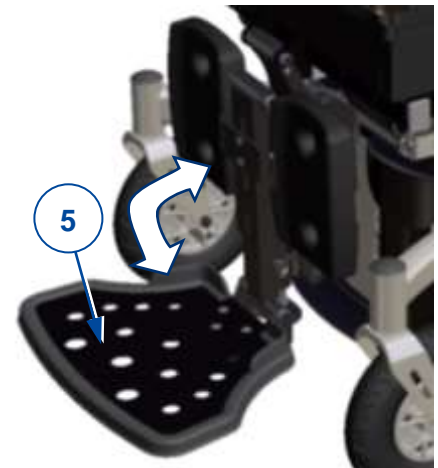

3.7.7 Leg rests BZ7-BZ8

1. Loosen the lever (13) at the rotation point.
2. Adjust the angle of the leg rest by lifting/lowering the footplates (between 100° - 190°).
3. Retighten the lever (13) firmly by hand.
4. Repeat this for the second leg rest. Make sure that both leg rests are firmly secured.



3.7.8 Headrest L58 (if applicable)

To mount:

1. Loosen the star knob (35).
2. Mount the square tube of the headrest (36) into the provided bracket (37).
3. Retighten the star knob (35) firmly by hand.

To remove, repeat the steps above in reverse order.

To adjust the height/depth

1. Loosen the levers (38).
2. Put the headrest into the desired position.
3. Retighten the levers (38) properly by hand.





3.7.9 Backrest adjustment SE36

Press the gas spring lever to unlock the inclination mechanism. Push down on the backrest until you reach the desired inclination.

3.8 Battery status and charging



WARNING

Risk of injuries and damage due to fire

- Only use the battery charger delivered with the wheelchair. The use of any other charger may be dangerous (fire hazard).
- The battery charger is only intended to charge the batteries delivered with the wheelchair, not to charge any other batteries.
- Do not adapt any of the delivered parts, like cables, plugs or battery charger. Never open or change the battery or the connection points.
- Protect the battery and battery charger against flames, high and low temperatures (see chapter 5), moisture, sunshine, severe shocks (for example dropping). Do NOT use the battery if this has been the case.
- Charge the battery with the battery charger, indoors, in a well-ventilated area, out of children's reach.
- First read the user instruction of the applied battery charger before charging the wheelchair's battery. For more information, contact your specialist dealer or consult our website <http://www.vermeiren.com/>

CAUTION

Risk of damage

- Battery self-discharge and the quiescent current of the connected users will drain the battery charge slowly. The battery may be irreversibly damaged if the battery is fully discharged. Therefore, make sure that the battery is charged on time (see manual of operating console).
- Read the storage and maintenance instructions in § 4.1 and technical details in chapter 5.
- Only disconnect the battery charger when the battery is fully charged.
- Do not charge batteries below 0°C. Move the battery to a warmer place and start charging.
- Keep the connection point for the battery charger free of dust and other contamination.
- In case of any problems whereby the battery cannot be charged according to following instructions, please contact your specialist dealer.
- For instructions on how to change the batteries, see the installation manual.

For all information on battery status indication, please read the manual of the operating console.

- i** It is recommended to unplug the battery charger from the mains when not in use. This is to prevent unnecessary energy consumption.

To charge the battery:

1. FIRST connect the battery charger to a 230V AC power socket. Use the battery charger directly, without extension cord, on the power supply (without time switch).
2. Plug the adapter in the charging point of the operating console.
3. Wait until the battery is fully charged. Consult the battery charger manual for more information.
4. Disconnect the battery charger.
5. Remove the battery charger from the socket, let it cool down and store it in the charger pocket.

4 Maintenance

- i** Regular care ensures that your wheelchair is preserved in a perfectly functional condition. For the maintenance manual, refer to the Vermeiren website: www.vermeiren.com.

4.1 Time of maintenance

 **CAUTION** Risk of injuries and damage

Repairs and replacements may only be undertaken by trained persons and only genuine replacement parts of Vermeiren should be used.

- i** The last page of this manual contains a registration form for the specialist dealer to record each service.

The service frequency depends on the frequency and intensity of use. Contact your dealer to agree to a common timetable for inspection/maintenance/repair.

Read the user instructions of the applied battery charger regarding maintenance.

Before each use

Inspect the following points:

- All parts: present, undamaged and unworn.
- All parts: clean, see § 4.2.2.
- Wheels, seat, calf rests, arm rests, footplate and headrest (if applied): well secured.
- Battery status: charge the battery when necessary, see §3.8.
- Operating console, battery, power module, motors, battery charger, lights and relevant cables: no damage such as wires that have become frayed, broken or exposed.
- Condition of wheels/tyres, see § 4.2.1.
- Condition of frame parts: no deformation, instability, weakness or loose connections.
- Seat, backrest, arm pads, calf pads and head rest (if applied): no excessive wear (like dented spots, damage or tears).

Contact your specialist dealer for possible repairs or part replacements.

Every month

If your wheelchair is stored for a longer period, you still need to charge the batteries every month. It is also possible to keep the battery charger connected to the battery and the mains during this period. For more information, see § 3.8.

Yearly or more often

Have your wheelchair inspected and serviced by your specialist dealer, at least once a year, or more often. The minimum maintenance frequency depends on use and should therefore be commonly agreed upon with your specialist dealer.

If stored

Make sure that your wheelchair is stored in a dry environment to prevent mould from growing, or the upholstery from being damaged.



4.2 Instructions for maintenance

4.2.1 Wheels and tyres

i Proper working of the brakes depends on the state of the tyres, that can change due to wear and contamination (water, oil, mud, ...).

- Keep your wheels free of wires, hair, sand and fibres.
- Check the profile of the tyres. If the tread depth is less than 1 mm, the tyres need to be replaced. Contact your specialist dealer for this matter.
- Inflate the pneumatic tyres to the correct pressure (see pressure indication on the tyres).
- For instructions on how to change the tyres, see the installation manual.

4.2.2 Cleaning

CAUTION

Risk of damage by moisture

- Keep the operating console clean and protect it from water and rain.
- Never use a hose or high-pressure cleaner to clean the wheelchair.

Wipe all rigid parts of the wheelchair with a damp cloth (not drenched). If necessary, use a mild soap, suitable for varnishes and synthetics.

The upholstery can be cleaned with lukewarm water and a mild soap. Do not use abrasive cleaning agents to clean.

Keep the ventilation openings of the battery charger clean and free of accumulated dust. Blow away the dust and clean the battery charger enclosure with a slightly moistened cloth, if required.

4.2.3 Disinfection

CAUTION

Risk of damage

Disinfections may only be undertaken by trained persons. Consult your specialist dealer.

4.3 Troubleshooting

Even if you use your wheelchair properly, a technical problem may occur despite this. In this case, contact your local specialist dealer.



WARNING

Risk of injuries and damage to the wheelchair

- NEVER attempt to repair your wheelchair yourself.
- For failures in the operating console you need to contact your specialist dealer. He/She will decide if the console needs to be reprogrammed.

In case of failure, a fault code is displayed on the operating console.

i For an overview of all fault codes on the operating console, please read the manual of the operating console.

The following symptoms may indicate a serious problem. Therefore, always contact your specialist dealer if you spot any of the following deviations:

- Strange sound;
- Frayed/damaged wiring harnesses;
- Cracked or broken connectors;
- Uneven tread wear at one of the tyres;



- Jerky movements;
- Wheelchair deflects to one side;
- Damaged or broken wheel assemblies;
- Wheelchair does not switch on (blown fuse);
- Wheelchair is powered but does not move, see 4.3.1.

4.3.1 Overload protection

To protect the motor against overload, the motor is automatically cut off in the following situations:

- driving up or down slopes that exceed the maximum gradient indicated in chapter 5.
- the nominal load exceeds its upper limit.

To use the wheelchair again: place joystick in neutral, remove the overload and wait until the motor has cooled down.

4.4 Reuse

Before each reuse, have the wheelchair disinfected, inspected and serviced according to the instructions in §4.1 and §4.2.

4.5 End of use

At end of life, you need to dispose of your wheelchair according to the local environmental legislation. The best way to do so, is to disassemble the wheelchair to facilitate the transport of recyclable parts.



5 Technical specifications

The technical details below are only valid for this wheelchair, at standard settings and optimal ambient conditions. Take these details into account during use. The values are no longer applicable if your wheelchair has been modified, damaged, or is severely worn. Be aware that the driving performance is influenced by ambient temperature, humidity, slopes (driving up/down), type of surface and battery status.

Table 1: Technical specifications

Brand	Vermeiren			
Type	Wheelchair			
Model	Sigma, Sigma 230			
Description	Dimensions per configuration with BZ10E and L34 TUB			
	SE30	SE39	SE43	SE42
Max. weight of user	140 kg			
Wheelchair class	B			
Overall length with leg rest	1177 mm		1163 mm	1198 mm
Overall width	580 mm - 630 mm - 680 mm			
Overall height	1055 - 1115 mm		1075 - 1135 mm	1100 - 1400 mm
Total mass	141 kg		154 kg	168 kg
Mass of the heaviest part	133.75 kg		146.75 kg	160.75 kg
Masses of removable parts	Footrest B06 Backrest Charger	1,95 kg (per piece) 3.35 kg 0,95 kg		
Static stability downhill	6°			
Static stability uphill	6°			
Static stability sideways	6°			
Energy consumption *	Drive A: 35 km Drive B: 35 km			
Dynamic stability uphill	6°			
Obstacle climbing	Sigma Sigma 230	50 mm (with a run-up of 0.5m) 65 mm (with a run-up of 0.5m)		
Maximum speed forward	Drive A: 6 km/h Drive B: 10 km/h			
Min. braking distance from max. speed	2.1 m			
Seat plane angle	0 - 21° (manual)	0 - 20° (electric)	0° - 50° (electric)	0° - 45° (electric)
Effective seat depth	420-440-460-480-500-520 mm			
Effective seat width	400 mm - 450 mm - 500 mm			
Seat surface height at front edge (adjustable)	435-450-465-480-495 mm		453 to 513 mm	478 to 778 mm
Backrest angle	0° - 30°			
Backrest height	610 mm			
Footrest to seat distance (BZ10E)	365 – 465 mm			
Leg to seat surface angle	90° - 153°			
Armrest to seat distance	250 – 530 mm			



Description	Dimensions per configuration with BZ10E and L34 TUB			
	SE30	SE39	SE43	SE42
Minimum turning radius	1200 mm			
Ground clearance (bottom base frame)	65 mm			
Diameter mid wheels	350 x 70 mm			
Type of mid wheels	3.00-8, air tyre			
Diameter front wheels	Sigma Sigma 230 200 x 50 mm 230 x 70 mm			
Type of front wheels	Rubber tyre			
Diameter balance wheels	140 x 40 mm			
Type of balance wheels	Rubber tyre			
Base frame with wheels – dimensions	Sigma Sigma 230 962 x 618 x 377 mm 962 x 672 x 377 mm			
Description electrical	Drive A		Drive B	
Battery (Non-spillable AGM battery, maintenance-free) Capacity: Output:	80 Ah (C20) 12V DC			
Driving motors	2 x 220W with EM brake		2 x 350W with EM brake	
Battery charger Input: Max. charging current: Protection class Insulation class II	220-240V AC, 50/60Hz 6 A IP21 II		220-240V AC, 50/60Hz 8 A IP21 II	
Power module	Blow fuse	150A	150A	
Description	Specification for all configurations			
Strength tests according to	ISO 7176-8			
Tests of power and control system according to	ISO 7176-14			
Ignitability of upholstery according to	EN1021-2:2006			
EMC compliance	ISO 7176-21			
Degree of protection	IPX4			
Noise level	< 65 dB (A)			
Storage and use temperature	+5 °C ~ +41 °C			
Operating temperature for electronics	-10°C ~ +40°C			
Storage and use humidity	30% ~ 70%			
We reserve the right to introduce technical changes. Measurement tolerance ± 15 mm / 1,5 kg / 1,5°. (*) The theoretical driving distance range will be reduced if the wheelchair is used frequently on slopes, rough ground or to climb curbs.				



Service registration form

This product (name):

was inspected (I), serviced (S), repaired (R) or disinfected (D):

By (stamp): Kind of work: I / S / R / D Date:	By (stamp): Kind of work: I / S / R / D Date:	By (stamp): Kind of work: I / S / R / D Date:
By (stamp): Kind of work: I / S / R / D Date:	By (stamp): Kind of work: I / S / R / D Date:	By (stamp): Kind of work: I / S / R / D Date:
By (stamp): Kind of work: I / S / R / D Date:	By (stamp): Kind of work: I / S / R / D Date:	By (stamp): Kind of work: I / S / R / D Date:
By (stamp): Kind of work: I / S / R / D Date:	By (stamp): Kind of work: I / S / R / D Date:	By (stamp): Kind of work: I / S / R / D Date:
By (stamp): Kind of work: I / S / R / D Date:	By (stamp): Kind of work: I / S / R / D Date:	By (stamp): Kind of work: I / S / R / D Date:



Vermeiren GROUP
Vermeirenplein 1 / 15
2920 Kalmthout
BE

website: www.vermeiren.com

Instructions for specialist dealer

This instruction manual is part and parcel of the product and must accompany every product sold.

Version: F, 2021-01

Basic UDI: 5415174 122127Sigma 6B
5415174 122127Sigma 230 5X

All rights reserved, including translation.

No part of this manual may be reproduced in any form what so ever (print, photocopy, microfilm or any other process) without written permission of the publisher, or processed, duplicated or distributed by using electronic systems.

© Vermeiren Group 2021